

KR-1W

Wave-Front Analyzer

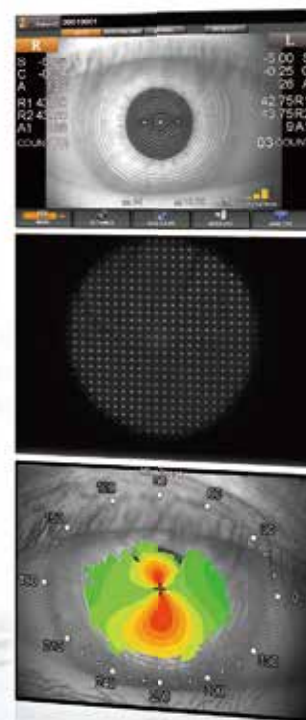

Perfection for Professionals: KR-1W

Topcon, with its wealth of experience in designing and manufacturing refractometers and other diagnostic equipment for over 50 years, introduces a new diagnostic tool with 5 functions to support the evaluation of the visual performance of the human eye. The KR-1W combines aberrometry, topography, keratometry, pupillometry and autorefractometry in one unit that is unparalleled in terms of functionality and reproducibility. At the same time the KR-1W is extremely easy to operate and allows fast patient throughput. The KR-1W will become the professional's choice for comprehensive diagnosis of many ocular conditions.



Features

- » 5 functions in 1 machine:
(Auto-Refractometry, Keratometry, Aberrometry, Topography and Pupillometry)
- » Multiple maps for overview analysis
- » Decision support for cataract and refractive procedures
- » Less stress with invisible light measurement at topography
- » Easier operation with R / L fully automated measurement and touch panel



A Picture Says More Than a Thousand Words

The multiple maps provide helpful insight for refractive procedures that are done on the corneal surface or intraocularly. It allows an objective quality control of the surgical procedures.

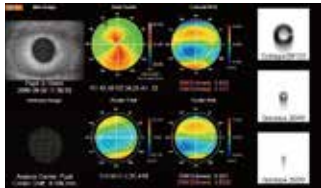

Multi Maps

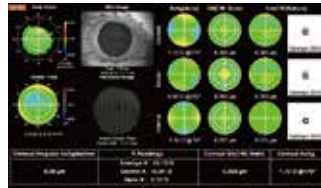

IOL Selection Maps

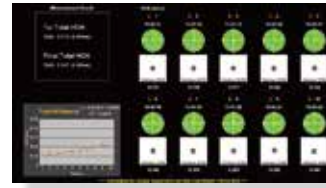

Summary Maps
(Continuous Measurement Maps)

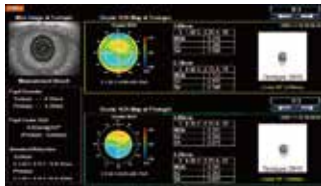

Pupillometry Maps

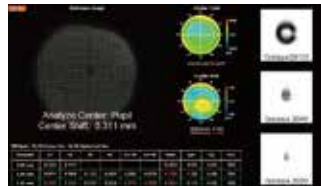

Ocular Maps

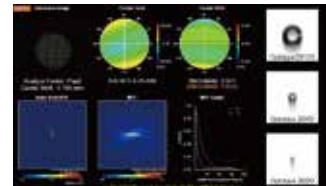

PSF/MTF Maps

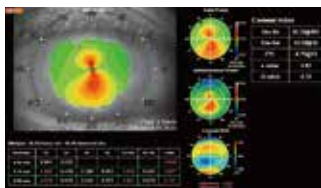

Corneal Maps

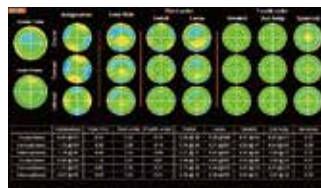

Component Maps

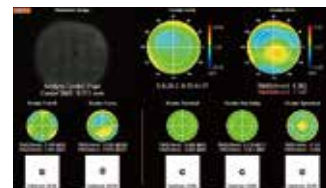

Zernike Vector Maps

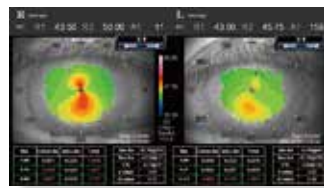

Corneal R/L Maps

Refraction Data						
	R			L		
	S	C	A	S	C	A
1	2.00	-1.25	82	2.25	-1.00	89
2	2.00	-1.25	82	2.25	-1.00	87
3	2.00	-1.25	82	2.25	-1.00	88
4	2.00	-1.25	81	2.25	-1.00	88
5	2.00	-1.25	88	2.25	-1.00	88
6						
7						
8						
9						
10						
Avg	2.00	-1.25	81	2.25	-1.00	87

Refraction-Keratometry





Work Flow

The KR-1W provides you with the ideal tool to diagnose, follow up and make treatment plans for a broad range of ocular conditions. It can be very effectively used in your practice to speed up your workflow, improve your communication with patients and to monitor the outcomes of your treatments. With the KR-1W you are able to assess your patients functional visual performance over time or pre / post operatively with unsurpassed reproducibility and reliability.



Unsurpassed reproducibility and reliability with fully automated measurement and touch panel manipulation make your diagnosis and treatment decision easy.

Enrich your communication with patients showing them the effect of their ocular condition on their visual performance.

CATARACT SURGERY

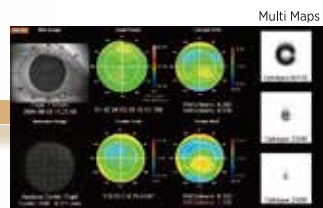

This is a case of cortical cataract displayed in the Multi Maps mode. [Go to page 7](#) for a clinical discussion of this case.

[Go to page 6](#)



Pupillometry
 ■ Multifocal IOL

[Go to page 5](#)



IOL Selection Support

- Aspherical IOL
- Spherical IOL
- Multifocal IOL
- Toric IOL

CORNEAL PATHOLOGY

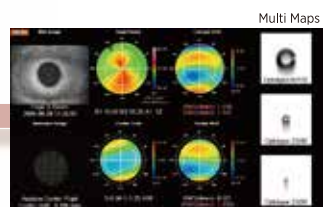

This is a keratoconus case displayed in the Multi Maps mode. [Go to page 7](#) for a clinical discussion of this case.

REFRACTIVE SURGERY

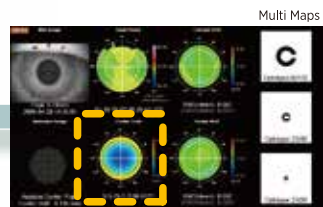

HOA

This is a case of myopia displayed in the Multi Maps mode. The concentric shape that can be observed in the Total Ocular Higher Order Aberration map (see box) with a blue center and a yellow periphery, indicates a typical case of myopia.

[Go to page 6](#)



Pupillometry
 ■ Halo or glare at night time



Treatment / Surgery

Ideal tool to make treatment plans for a broad range of ocular conditions.



Follow-Up

This work flow will increase patient satisfaction and confidence in their choice of treatment as you can objectively show the patient the outcome of your treatments.

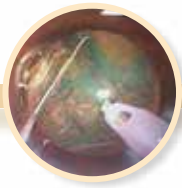

IOL Implantation

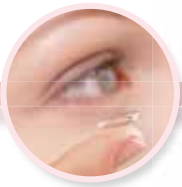

Contact Lens Fitting



Corneal Transplant

- DSAEK
- DALK
- Limbal Relaxing Incision
- Others



Refractive Surgery

- LASIK
- LASEK
- PRK
- Others



FOLLOW-UP

Reliable Decision Support for the Demanding Cataract & Refractive Surgeon

» IOL Selection

Important factors in making the right IOL selection for your patient at one glance.

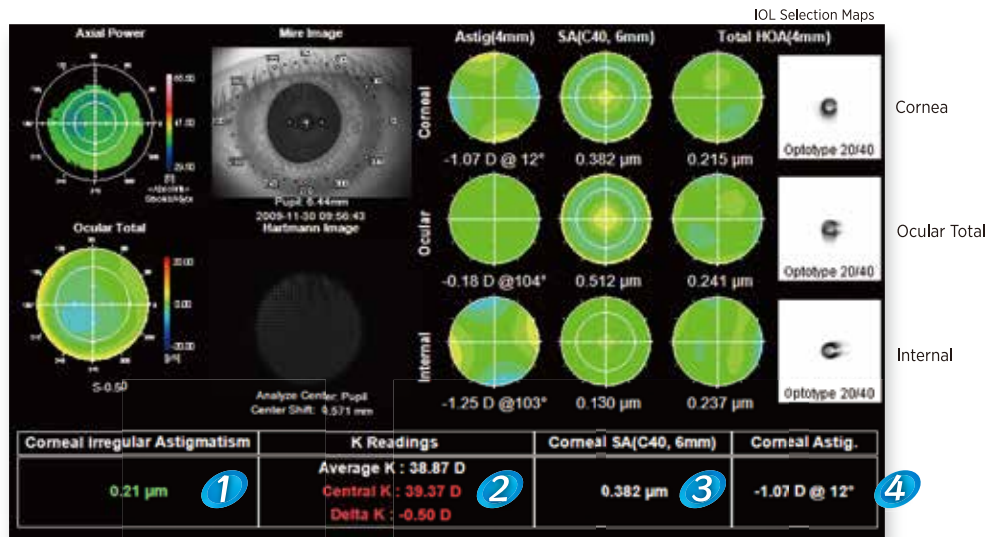

- 1** ■ below 0.3 μm
■ between 0.3 μm and 0.6 μm
■ above 0.6 μm
- 2** ■ within $\pm 0.73\text{D}$
■ over $\pm 0.73\text{D}$
※ $\Delta K = \text{Average K} - \text{Central K}$
- 3** ■ below 0.1 μm
- 4** ■ below -1.5D
above +1.5D

※ These thresholds are recommendation from Naoyuki Maeda, MD Osaka University Hospital

1 Corneal Higher Order Aberration Index

This index provides information on the potential visual outcome considering the aberration that cannot be corrected by an IOL. Additional treatments, i.e. contact lens fitting or corneal surface treatments, might be necessary to optimize the outcome.

3 Corneal Spherical Aberration Index

This index provides very useful information on the asphericity of the cornea. This gives you the opportunity to select the right monofocal IOL to compensate for the spherical aberration of the patients' cornea.

2 Post Refractive Surgery Index

This index provides information on corneal irregularities possibly caused by previous surface treatments of the cornea. This might lead to the necessity of calculating the power of the IOL with non-standard formulas with special attention.

4 Corneal Astigmatism Index

This simple display of corneal astigmatism provides information for two important decisions.

- a. Amount of toric correction needed in a toric IOL
- b. Patients with a high corneal astigmatism might not be the right candidate for a multifocal IOL

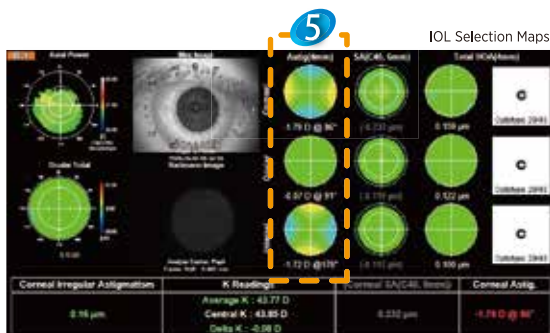

※Data: provided by Tokyo Medical and Dental University Hospital Faculty of Medicine

5 Review after Toric IOL Implantation

The result after implantation can be reviewed to check residual ocular astigmatism.

[Go to page 8](#)

» Pupillometry

Screening application to evaluate eyes for multifocal IOL implantation or refractive surgery.



Corneal Refractive Surgery

For any refractive procedure it is vitally important to diagnose the pupil very carefully in different light conditions.

Also for refractive surgery this tool gives you the necessary information to plan your treatment.



Dynamic Pupil Diameter Measurement and Pupil Center Determination

This information is very important for premium IOL implantation, as it will give you the possibility to select the right multifocal IOL design for the individual eye and also help exclude extreme cases of pupil decentration before surgery.

Pupillometry Maps

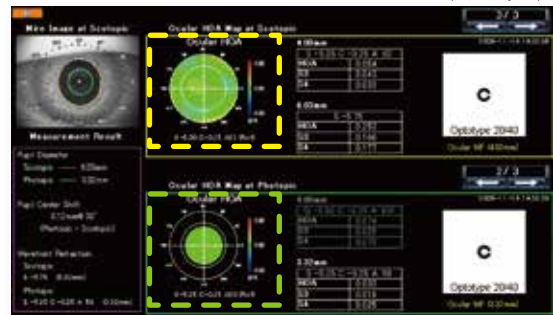

Ocular HOA Map at Scotopic

Ocular HOA Map at Photopic

The index of Ocular Total Higher Order aberration, refraction data are provided in photopic and scotopic condition.

Continuous Measurement Function

Up to 10 measurements can be done continuously to observe the change in ocular HOA during about 10 seconds. This may have implication for dry eye diagnosis in the future.

Summary Maps

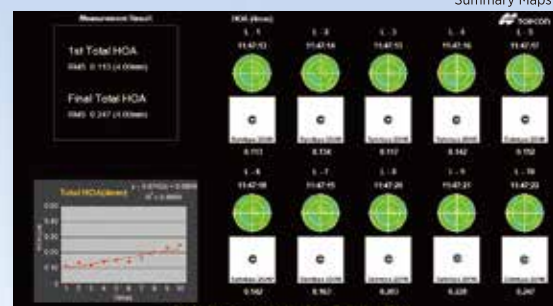

※Data: provided by Tohoku University

Precise Data Leads to Precise Diagnosis

Case Report

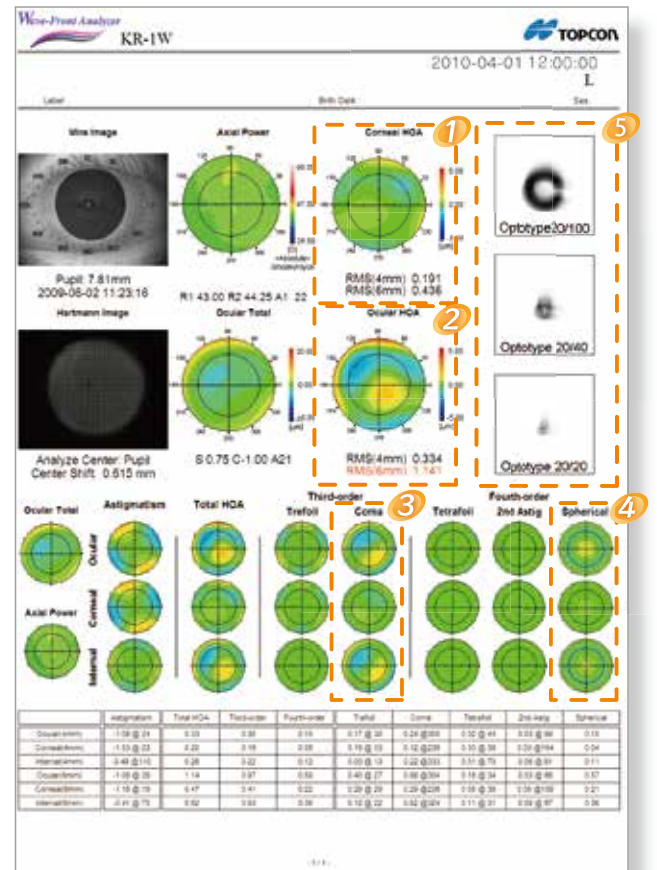
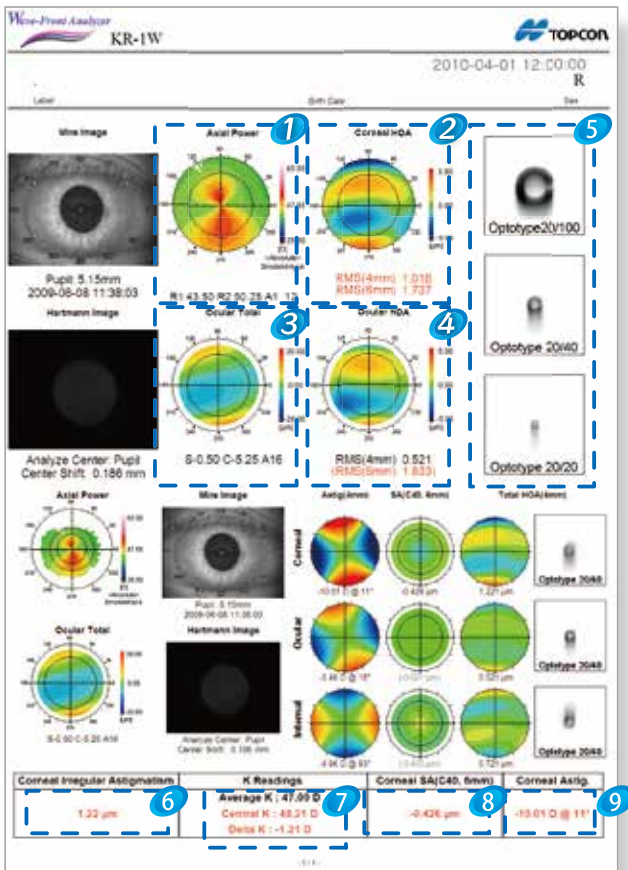

Clinical Data ; Osaka University Hospital
Editorial supervisor ; Naoyuki Maeda, MD

Keratoconus

This is a case of moderate keratoconus. The results of corneal topography are shown at the top row. Axial Power map **1** indicates typical topographic appearance of keratoconus such as inferior steepening (warmer colors) and skewed axis. The map for the corneal HOA (higher-order aberration) **2** shows remarkable vertical coma pattern with advanced wavefront (warmer colors) at the superior portion and delayed wavefront (cooler colors) at the inferior cornea. The second row represents the results of ocular aberrations. The ocular total aberration map **3** shows delayed wavefront in the center. This suggests that uncorrected visual acuity is not good due to myopic astigmatism. The map for ocular HOA **4** is similar to that for corneal HOA indicating that ocular HOA are mainly attributing from cornea and best spectacle corrected visual acuity is not good. Simulated retinal images of the Landolt rings **5** suggests that comet-like image will be seen because of vertical coma. In the lower half of the print, IOL selection maps and four outputs are shown. The output for corneal astigmatism **6** indicates the existence of significant irregular astigmatism with red signal. The difference between central power and K reading **7** suggests that conventional IOL calculation might induce refractive error due to topographic abnormality. The output for corneal spherical aberration (SA) suggests that the spherical IOL (positive SA) is more appropriate than aspherical IOL (negative SA) because of the negative corneal spherical aberration **8**. The last output is for corneal cylinder and shows that regular astigmatism is extremely high **9**.

Clinical Data ; Osaka University Hospital
Editorial supervisor ; Takashi Fujikado, MD

Cortical Cataract

This is a case of a 62 year old female with cortical cataract. Her visual acuity is 0.8 with correction in the right eye. The corneal HOA **1** is within normal limit but the Total Ocular HOA **2** shows a higher RMS (red indication) at 6mm pupil diameter. Referring to the Component Maps in the lower half of the print, the coma aberration is higher in oculus than in cornea. It is therefore easily observed that the coma aberration is mainly caused by internal components (crystalline lens) **3**. The spherical aberration is also higher in oculus than in cornea, indicating that spherical aberration is increased in the crystalline lens **4**. Referring to the Landolt's ring simulation **5**, it can be seen that the images are vertically distorted, which show the visual effect of the coma aberration. The image simulation is consisted of ocular HOA only, so it should be noted that this simulated image might not coincide with actual patient vision because the opacity of crystalline lens and subsequent light scattering affects the retinal image differently with ocular HOA.



Slit Lamp Anterior Image

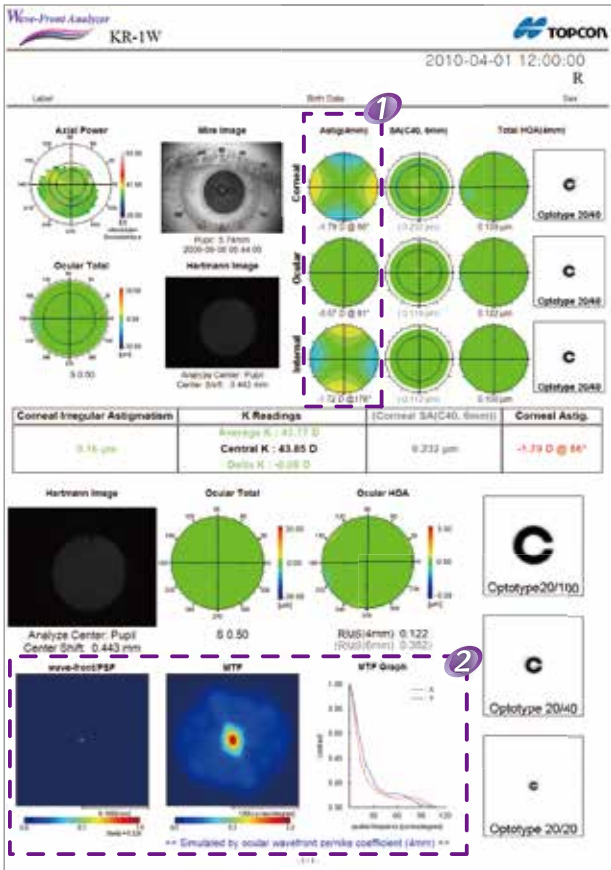

Clinical Data ; Tokyo Medical and Dental University Hospital Faculty of Medicine
 Editorial supervisor ; Hiroko Bissen-Miyajima, MD

Pseudophakic Eye with Toric IOL

This measurement shows in the upper half the IOL selection map, where it can be shown that the toric IOL is properly implanted and the corneal astigmatism is compensated by the implant. Reference values parameters are: Corneal Astigmatism (showing -1.79D@86), Ocular Astigmatism (showing -0.07D@91) and Internal Astigmatism (showing -1.72D@176). ① In the lower half the PSF/MTF maps show that objective visual quality should be good as can be seen from the simulated PSF, that gives an indication of optical image quality, and from the MTF that gives an indication of contrast sensitivity ②.

Customizable Print Layout

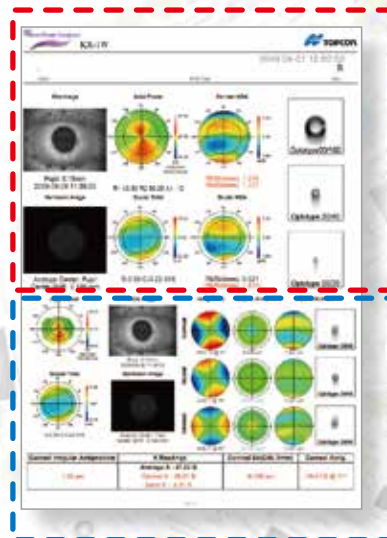

Multi Maps

IOL Selection Maps

Example

2 analysis maps of your choice can be assembled to print layout on 1 page for printing and / or sending images to external systems, like IMAGENet.™

Full Flexibility for Your Data Viewing or Data Storage Needs

System Chart

The KR-1W is adaptable to your networking and data filing needs since various combinations are available.

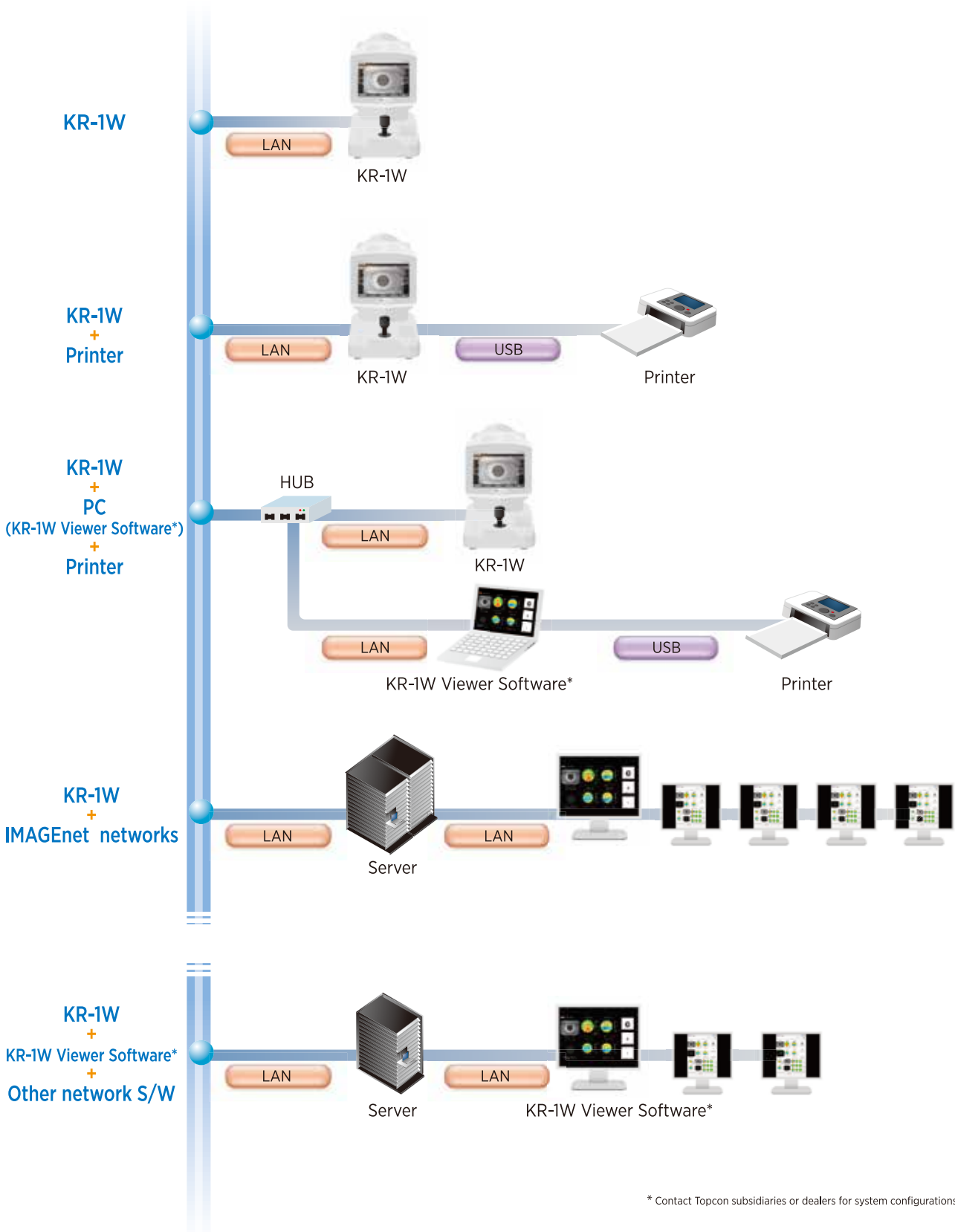

* Contact Topcon subsidiaries or dealers for system configurations.

Wave-Front Analyzer **KR-1W**

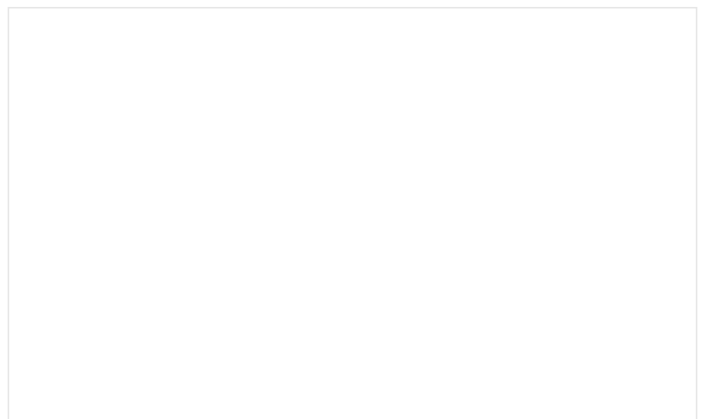

Specifications

Refractive Power Measuring Range

Sphere Range	-25D~+22D (0.01D/0.12D/0.25D steps) ※
Cylinder Range	0D~±10D (0.01D/0.12D/0.25D steps) ※
Axis Range	0°~180° (1°/5°steps)
Measurable Area	φ 8 mm (max.)
Measurable Minimum Pupil Diameter	φ 2mm

Corneal Curvature Measuring Range

Corneal Curvature Radius	5.00mm~10.00mm (0.01mm steps)
Corneal Refraction	67.5D~33.75D (0.01D/0.12D/0.25D steps) (Proviso: corneal refractive index = 1.3375)
Corneal Astigmatism	0D~±10D (0.01D/0.12D/0.25D steps)
Corneal Astigmatism Axial Angle	0°~180° (1°/5°steps)
Measurable Corneal Area	φ 0.8mm~ φ 9.2mm (Proviso Radius corneal curvature = 8mm)
Measurable PD Range	20~85mm (1mm step)
Export Output Terminal	USB (IN/OUT) 、RS232C (OUT) 、LAN (IN/OUT)

Other Specifications

Dimensions	304(W) x 521(D) x 474-504(H) mm
Weight	23kg
Power Supply	100-240VAC, 50-60Hz /160VA

※Proviso:Sphere +Cylmlder ≤ +22D, or Sphere+Cylmlder ≥ -25D



IMPORTANT In order to obtain the best results with this instrument, please be sure to review all user instructions prior to operation. Not all products, services, or offers are available in all markets. Contact your local distributor for country-specific information and availability.

TOPCON INSTRUMENTS (MALAYSIA) SDN. BHD.
(Regional Office for Topcon Healthcare Southeast Asia)
Unit 2, 4, Jalan Pensyarah U1/28, Hicom-glenmarie Industrial Park,
40150 Shah Alam, Selangor, MALAYSIA
Phone: +603-766 16260 Fax: +603-766 16261
Email: mys_tim_marketing_sm@topcon.com
www.topconhealthcare.my

TOPCON SINGAPORE MEDICAL PTE. LTD.
100G Pasir Panjang Road, #02-18, Interlocal Centre,
SINGAPORE 118523
Phone: +65-68720606 Fax: +65-67736150
E-mail: med.sales.sg@topcon.com
www.topconhealthcare.sg

TOPCON INSTRUMENTS (THAILAND) CO., LTD.
77/162 Sinnsathorn Tower, 37th Floor, Krungthoburi Rd.,
Klongtomsai, Klongsarn, Bangkok 10600, THAILAND
Phone: +66-02-440-1152 Fax: +66-02-440-1158
Email: tha_medical@topcon.com
www.eyecare.topcon.co.th

MEHRA EYETECH PRIVATE LIMITED
801 B Wing, Lotus Corporate Park, Graham Firth Steel Compound
Goregaon (East) Mumbai 400063 Maharashtra, INDIA
Phone: +91-22-61285455
E-mail: sales@mehraeyetech.in
www.topconhealthcare.in

TOPCON (BEIJING) MEDICAL TECHNOLOGY CO., LTD.
Room 2808, Tower C, JinChangAn Building, No.82, Middle Section of
East 4th Ring Road, Chaoyang District, Beijing 100124, P.R. CHINA
Phone: +86-10-8794-5176
E-mail: cn_marketing@topcon.com
www.topcon-china.net/

TOPCON KOREA MEDICAL CO., LTD.
2F YK Building, 205, Dogok-ro, Gangnam-gu,
Seoul, Republic of Korea
Phone: +82-2-6959-7947
E-mail: tkm@topcon.com
www.topconhealthcare.kr/



TOPCON CORPORATION

75-1 Hasunuma-cho, Itabashi-ku, Tokyo 174-8580, JAPAN.
Phone: +81-(0)3-3558-2522/2502
Fax: +81-(0)3-3965-6898
www.topconhealthcare.jp

